

Effect of Benzotriazole on Corrosion Resistance of Al₂O₃/Cerium Oxide Composite Films on the Al Surface

Wang Guixiang, Gao Gang, Han Xinchun, Ying Lixia, Ma Fuqiu

Harbin Engineering University, Harbin 150001, China

Abstract: Al₂O₃/cerium oxide composite films were prepared on the surface of aluminum by an anodic oxidation and chemical conversion method. The aluminum was firstly anodized in sulfuric acid, and then the anodized aluminum was treated with the Ce(NO₃)₃ solution. The effect of different concentrations of 1H-Benzotriazole (BTA) on the corrosion resistance of Al₂O₃/cerium oxide composite films was investigated. X-ray diffraction (XRD), X-ray photoelectron spectroscopy (XPS), scanning electron microscope (SEM) with energy dispersive spectrometer (EDS), and electrochemical workstation were used to characterize the properties of the composite films. The results show that the deposition effect of cerium ions is optimal in 0.5 g/L BTA. At the same time, the surface uniformity and smoothness of the composite films are both enhanced. And the corrosion resistance of the composite film is strengthened.

Key words: aluminum; cerium conversion coatings; BTA; corrosion resistance

On account of the advantages of their relatively low density, strong weldability, easy processing, and good mechanical strength, etc, aluminum and its alloys are widely used in various fields^[1-3]. Due to the active chemical properties of aluminum, it will generate a thin layer quickly which has weak corrosion resistance and wear resistance when its fresh surface is exposed to the air. So this kind of oxide film cannot meet the needs of industry. Thus, the aluminum and aluminum alloys cannot be used unless their surfaces are treated. The traditional technique for surface treatment includes anodic oxidation, plasma spraying, wear corrosion-resistant coating technology, etc. The current researches and development of anodic oxidation are also relatively mature^[4]. The anodic aluminum oxide film has universal applications in many advanced industry fields^[5] because of its outstanding mechanical properties, excellent corrosion resistance, good tribological properties, surface adsorption, and other advantages. However, the corrosion ions can be easily adsorbed on the anodic aluminum oxide film for the film's porous structure, which would result in poor resistance corrosion. Therefore, it is necessary to seal the holes of the

anodic oxidation film^[6] by steam sealing method, enclosed nickel salt, dichromate sealing method, etc^[7-9].

With the awareness of environmental protection and health requirements, and the issued policies for the relevant environmental protection and energy saving, researchers gradually began to search for new, green and low energy sealing processes. At present, there are four major green closing processes: enclosed organic acids, enclosed rare earth salt, enclosed microwave hydration, and sol-gel method closure. The enclosed rare earth salt^[10,11] is the main focused research. According to the data reported^[12,13], the most widely used method of the rare earth salt sealing process for anodized film is a chemical impregnation method. In 2010, Li et al^[14] modified the anodized aluminum by chemical impregnation method with Ce and Nd, and this research has obviously improved the resistance corrosion of Al₂O₃ films.

In the corrosion of aluminum, inhibitors are usually added. BTA is a commonly used corrosion inhibitor^[15]. Zhao et al^[16] synthesized an inhibitor (BTA) with a structure of strawberry-shaped hollow microspheres and explored the corrosion resistance for copper. The test results show that the

Received date: December 14, 2017

Foundation item: National Natural Science Foundation of China (51479037); Fundamental Research Funds for the Central University (HEUCFM20171009, HEUCFM20171001)

Corresponding author: Wang Guixiang, Ph. D., Associate Professor, Harbin Engineering University, Harbin 150001, P. R. China, E-mail: wgx0357@126.com

Copyright © 2018, Northwest Institute for Nonferrous Metal Research. Published by Elsevier BV. All rights reserved.

corrosion resistance is very good. BTA also plays an important role in the corrosion protection for aluminum and aluminum alloys. If BTA was added into to a solution for preparing cerium conversion coatings, it could not only play a role of corrosion inhibitor of aluminum, but also be complexed with cerium ions. So BTA can effectively improve the microstructure of cerium conversion coatings.

In this experiment, BTA was added to the immersion liquid of cerium conversion coatings as an organic stabilizer. And this paper is intended to explain the effect of the addition contents of BTA on the corrosion resistance of Al_2O_3 /rare earth oxide composite films.

1 Experiment

1.1 Materials

The substrate used in this research was 1060 aluminum (nominal composition (wt%): Al>99.6, Fe<0.35, Mn<0.03, Mg<0.03, Si<0.25, Zn<0.05, Ti<0.03, Cu<0.05), whose size was 50 mm×15 mm×1 mm. The surfaces of aluminum samples were ultrasonically cleaned by ethanol, and then the samples were ultrasonically cleaned in mixed alkali containing 5 g/L sodium citrate, 1 g/L sodium silicate, 8 g/L sodium hydroxide, and 40 g/L trisodium phosphate anhydrous. Lastly the panels should be washed by a mixed acid containing 100 g/L sulfuric acid and 50 g/L phosphoric acid. After each step, the samples needed to be rinsed in distilled water and dried in air.

1.2 Preparation of composite films

The samples were anodized in a 49 g/L sulfuric acid electrolyte for 1 h using WYK-30010 DC power supply (Yangzhou Huatai Company). The current density was 1 A/dm², and the graphite (50 mm×40 mm×5 mm) was used as the cathode. After anodizing, the panels were cleaned in distilled water and dried in air.

Cerium conversion coatings were prepared by a chemical impregnation method on the surface of anodic oxide films under the water bath conditions at 50 °C for 30 min. Different densities of BTA were added into the immersion liquid containing 2 g/L $\text{Ce}(\text{NO}_3)_3 \cdot 6\text{H}_2\text{O}$ and 20 mL/L H_2O_2 . BTA contents were 0, 0.25, 0.50, 1.00, 1.50 g/L.

1.3 Evaluation of composite films

The microstructure of composite films was analyzed by using SU-70 scanning electron microscope which was produced by Hitachi High-Technologies Corporation. X-ray diffraction (XRD, D/max-TTR III) was used to characterize the crystalline structure of Al_2O_3 /cerium oxide composite films. Element distribution was acquired by scanning electron microscope (SEM) with energy dispersive spectrometer (EDS)-Mapping. And X-ray photoelectron spectroscopy (XPS) was used to obtain the element content and valence.

The corrosion behavior of the composite films was evaluated using a commercial model CHI760E electrochemical workstation in a three electrode cell, where the

sample was used as the working electrode, and a platinum sheet and saturated calomel electrode (SCE) were the counter and the reference electrodes, respectively. A sample area of 1 cm² was exposed to NaCl solution. The test frequency of electrochemical impedance spectroscopy (EIS) ranged from 105 Hz down to 10⁻² Hz, and the scanning voltage was 10 mV. The EIS spectra of the composite films were fitted using ZSimpWin software. The potentiodynamic polarization curves were recorded on independent specimens starting from the corrosion potential. The scanning rate of the polarization curves was 1 mV/s, and the scanning voltage was ±0.5 V. All the tests were performed in 3.5 wt% NaCl solution at room temperature.

2 Results and Discussion

2.1 Crystalline structure of composite films

Fig.1 shows the XRD pattern of Al_2O_3 /cerium oxide composite films under 50 °C water bath conditions for 30 min in the electrolyte which contains 2 g/L $\text{Ce}(\text{NO}_3)_3 \cdot 6\text{H}_2\text{O}$, 20 mL/L H_2O_2 , 0.5 g/L BTA. We can see in Fig. 1 that there are two peaks of Al_2O_3 around 65° and 78°. The miller indexes are (040) and (313), respectively. In the figure, there are only diffraction peaks of Al_2O_3 , and the intensity of peaks is strong. The cerium oxide peak at 22°~27° in the pattern indicates a amorphous phase structure of the cerium conversion coating.

2.2 Microstructure of composite films

The surface of the matrix without any pretreatment was silver white. After anodizing the aluminum, the surface was a layer of transparent and dense oxide film. When the cerium conversion coating was obtained, the color would turn into yellowish.

The stabilizer addition could effectively control the deposition rate of cerium ions and prevent the accumulation of cerium oxide. A uniform deposited composite film would be obtained. Fig.2 shows the microstructures of Al_2O_3 /cerium oxide composite films which are immersed in a solution containing 2 g/L $\text{Ce}(\text{NO}_3)_3 \cdot 6\text{H}_2\text{O}$, 20 mL/L H_2O_2 and different contents of BTA (0.25, 0.5, 1 and 1.5 g/L) at 50 °C for 30 min.

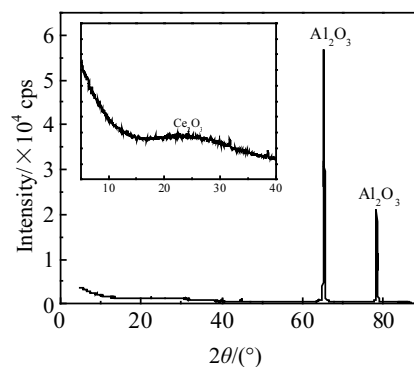

Fig.1 XRD pattern of Al_2O_3 /cerium oxide composite films acquired from the electrolyte with 0.5 g/L BTA

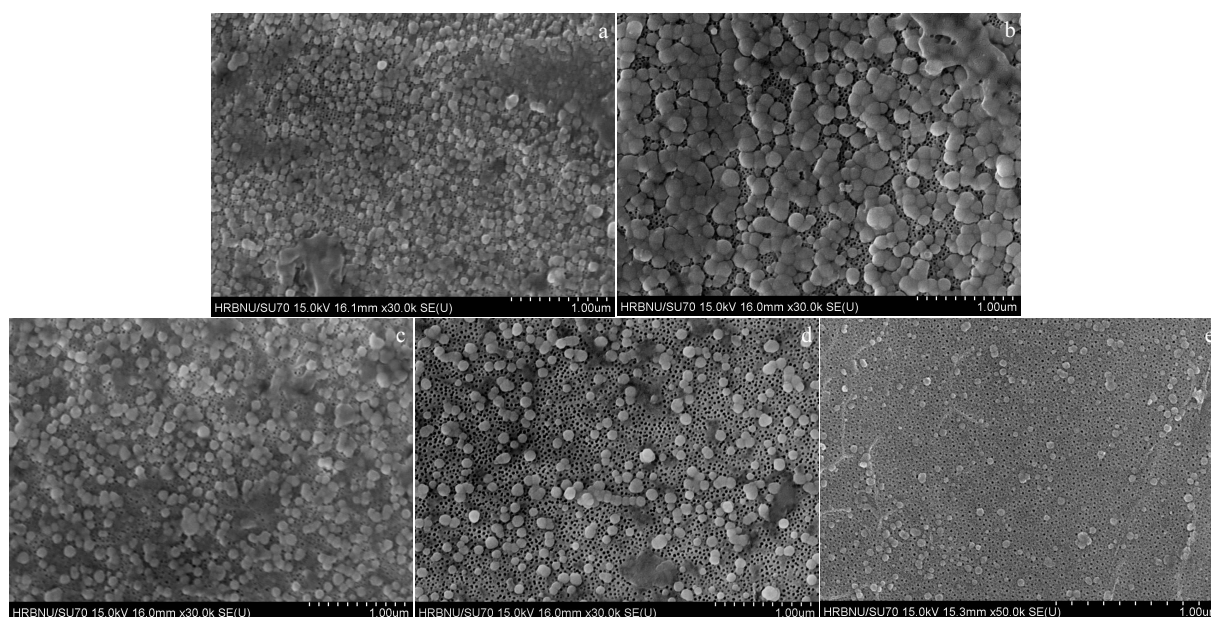

Fig.2 Microstructures of Al_2O_3 /cerium oxide composite films acquired from the electrolyte with different concentrations of BTA: (a) 0.25 g/L, (b) 0.5 g/L, (c) 1.0 g/L, (d) 1.5 g/L, and (e) 0 g/L

As shown in Fig. 2a, when the content of BTA is 0.25 g/L, the cerium conversion particles are tight and nonuniform, which leads to accumulation of particles. Less stabilizer in the sealed hole solution results in a quicker deposition rate compared to that of other cerium oxides. However, the microstructure of Al_2O_3 /cerium oxide composite films immersed in a solution containing 0.5 g/L BTA (Fig.2b) is smooth and the hole sealing effect is better.

In addition, the size of the cerium conversion particles is about 15 nm. The surface of the film failed to cover completely when the contents of BTA reached 1 and 1.5 g/L (Fig.2c and 2d), due to the fact that the obstructed deposition of cerium oxide let the cerium particles become less depositional and sparse. As BTA, an aluminum corrosion inhibitor, is absorbed by the surface of the Al_2O_3 porous layer, the higher the content of BTA in the immersion solution, the stronger the complex effects of BTA and cerium ions, which will also seriously hinder the deposition reaction of cerium ions.

The sectional view of Al_2O_3 /cerium oxide composite films under 50 °C water bath conditions for 30 min in the electrolyte containing 2 g/L $\text{Ce}(\text{NO}_3)_3 \cdot 6\text{H}_2\text{O}$, 20 mL/L H_2O_2 and 0.5 g/L BTA is shown in Fig.3. The thickness of the cerium conversion coating is 2.5 μm , the section is neat and the gap between the Al_2O_3 film and cerium oxide film is very small. What's more, there is no crack or shedding phenomenon in the section. Thus, the composite films has good plasticity and adhesion.

2.3 Component analysis of composite films

XPS spectra of composite films obtained from the solution

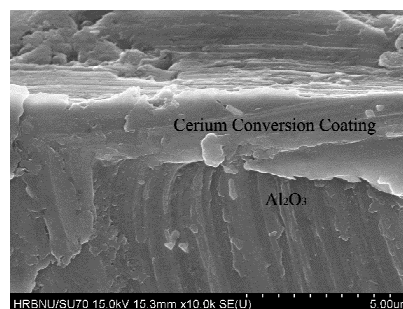
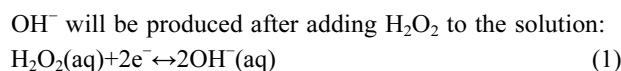

Fig.3 Sectional view of Al_2O_3 /cerium oxide composite films acquired from the electrolyte with 0.5 g/L BTA

containing 2 g/L $\text{Ce}(\text{NO}_3)_3 \cdot 6\text{H}_2\text{O}$, 20 mL/L H_2O_2 , 0.5 g/L BTA at 50 °C for 30 min are shown in Fig.4. Fig.4a is the binding situation of all elements in the composite films, while Fig.4b and Fig.4c show the valence of O and Ce, respectively. It can be seen that the composite films contain O, Al and Ce. And their bonding orbitals are O 1s, Al 2s, Ce 3d_{3/2}, Ce 3d_{5/2}. The valence of Al is +3 and it exists in the form of Al_2O_3 , while Ce exists in two forms, CeO_2 and Ce_2O_3 . Fig.4c illustrates that the presence status of Ce is mainly CeO_2 , because the peak of Ce_2O_3 only appears near 885 eV and its intensity is weak, which apparently demonstrates that the composite films only contain few Ce_2O_3 . According to the study by Valdez et al^[17], the deposition mechanism of Ce conversion coating is as follows:



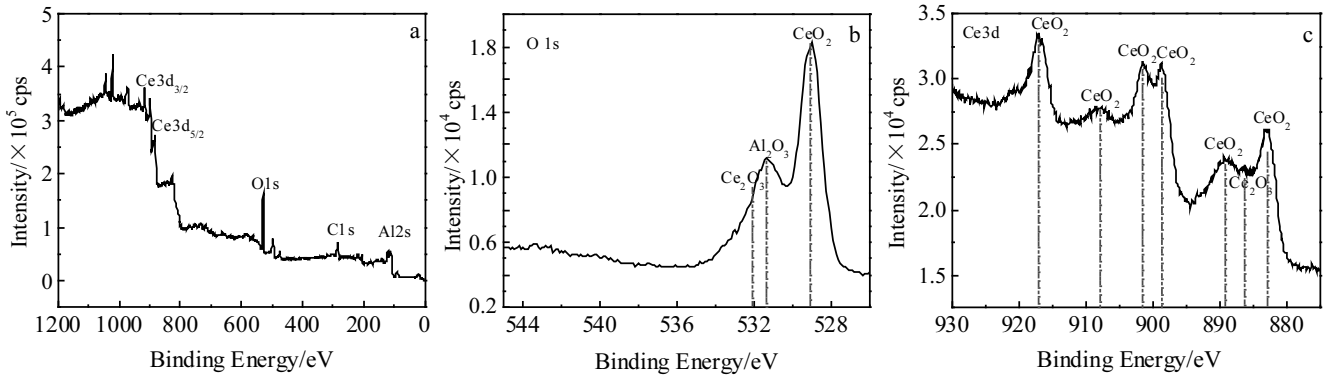
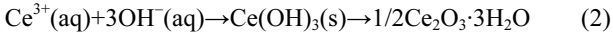
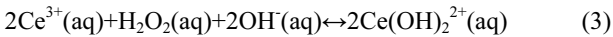

Fig.4 XPS spectra of Al₂O₃/cerium oxide composite films acquired from the electrolyte with 0.5 g/L BTA

After OH⁻ is generated, it will react with Ce³⁺. Therefore, the composite films will have Ce₂O₃. The reaction process is as follows:



Simultaneously, Ce³⁺ can be oxidized to Ce⁴⁺ under the role of H₂O₂. This is why the CeO₂ is contained in the composite films:



Because of the oxidation of H₂O₂, most of the Ce³⁺ is oxidized to Ce⁴⁺ in electrolyte, and Ce mainly exists in the form of CeO₂ in Al₂O₃/cerium oxide composite films.

Fig.5 shows the partial element distribution of Al₂O₃/cerium oxide composite films when the concentration of BTA is 0.5 g/L.

The distribution of each element on the surface of Al₂O₃/cerium oxide composite films could be gained according to these spectra. With the largest content, Al is also distributed uniformly in the black side of the composites films because the anodic oxidation film is a base film. With a large proportion in the composite film, Ce is the main component of the outer layer structure of the composite films. Moreover, Ce also has an even distribution without agglomeration phenomena. C and N appear in the composite films, which show that they are involved in the forming process. The composite films are formed by Al₂O₃ and cerium oxide, so the most abundant element is Ce. And this result can be proved in Fig.5f. It is clear that the films are rich in Ce, which is uniformly distributed.

2.4 Corrosion resistance of composite films

Fig.6 is EIS results of Al₂O₃/cerium oxide composite films

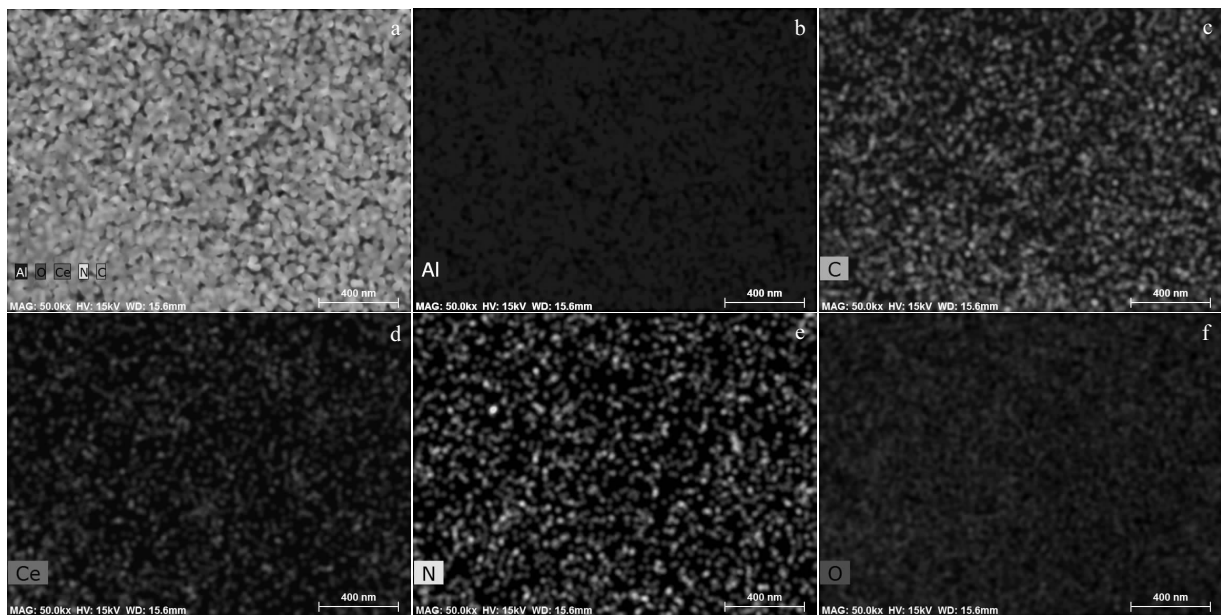

Fig.5 SEM image (a) and EDS element distribution of Al (b), C (c), Ce (d), N (e), and O (f) of Al₂O₃/cerium oxide composite films acquired from the electrolyte with 0.5 g/L BTA

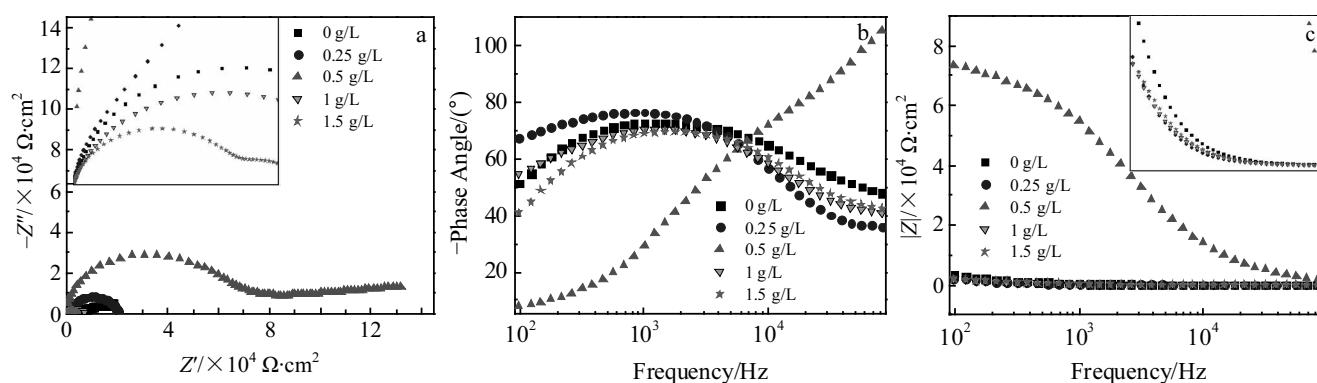

Fig.6 EIS plots of Al_2O_3 /cerium oxide composite films with different concentration of BTA in 0.1 mol/L NaCl solution: (a) Nyquist, (b) Bode phase diagram, and (c) Bode mode diagram

in 0.1 mol/L NaCl solution acquired from the electrolyte containing 2 g/L $\text{Ce}(\text{NO}_3)_3 \cdot 6\text{H}_2\text{O}$, 20 mL/L H_2O_2 and different concentrations of BTA (0, 0.25, 0.5, 1.0, 1.5 g/L) under 50 °C for 30 min. The upper left corner is a partial enlarged view of the high frequency region in Fig.6a. Fig.6b and Fig.6c are the Bode phase diagram and the Bode mode diagram, respectively.

It is clear that the capacitive arc radius of composite films obtained from the solution containing 0.5 g/L BTA is much larger than that of others. Therefore, under this condition, the corrosion resistance of Al_2O_3 /cerium oxide composite films is effectively improved. However, with the increasing concentration of BTA, the capacitive arc radius of the composite films decreases, which illustrates a declined corrosion resistance of composite films. Nyquist curves show that when the solution containing 1 g/L BTA or 1.5 g/L BTA, the corrosion resistance of composite films is worse than that of the composite films acquired from the solution without BTA. In the Nyquist curve, the order of the capacitive arc radius is 0.5 g/L > 0.25 g/L > 0 g/L > 1 g/L > 1.5 g/L. This rule reflects the corrosion resistance changes of composite films. Thus, adding an appropriate amount of BTA can effectively improve the resistance corrosion of composite films.

Fig.6b shows that there is a time constant which is related to the response of Al_2O_3 /cerium oxide composite films at $10^3 \sim 10^4$ Hz. In Fig.6c, with the increasing concentration of BTA, the impedance values show a trend of first increasing and then decreasing at a low frequency (about 10^2 Hz). In addition, by adding 0.5 g/L BTA to the solution, the impedance values of composite films increase by four orders of magnitude compared with that in other concentrations. It also illustrates that the optimum concentration of BTA is 0.5 g/L, which can effectively enhance the corrosion resistance of the composite films and attain an excellent protective effect on matrix.

Using the equivalent circuit module, the EIS was simulated and the results are shown in Fig.7 according to the shape of

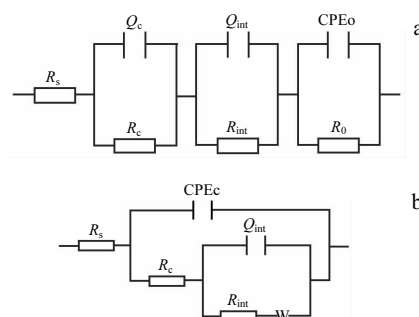

Fig.7 Equivalent circuits used for numerical simulation of the EIS plots: (a) equivalent circuits of 0, 0.25, 1.0, 1.5 g/L BTA; (b) equivalent circuits of 0.5 g/L BTA

Nyquist curves. It is shown that if different concentrations of BTA are added, the corrosion mechanism is also different. Fig.7a is the equivalent circuits with different concentrations of BTA, and these concentrations are 0, 0.25, 1.0, 1.5 g/L. In Fig.7b, the equivalent circuit of the 0.5 g/L BTA, where R_s represents the resistance of solution; R_c represents the resistance of cerium oxide film; R_{int} represents the resistance of interface; R_o represents the resistance of Al_2O_3 film; CPE_c , Q_c , Q_{int} , CPE_o represent the capacitor of the cerium oxide film, interface, Al_2O_3 layer, respectively. The conclusion could be drawn that when the concentration of BTA is 0.5 g/L, the protective effect of the composite film on the substrate is strong, and the corrosive ions could not penetrate into the cerium oxide film. Therefore, under other BTA concentration conditions, the corrosive ions pass through the cerium oxide film, and begin to corrode the porous Al_2O_3 film.

Fig.8 shows the potentiodynamic polarization curves recorded on Al_2O_3 /cerium oxide composite films which are acquired from the electrolyte with different concentrations of BTA (0, 0.25, 0.5, 1.0, 1.5 g/L) in 0.1 mol/L NaCl solution. The corrosion current density (i_{corr}) and corrosion potential (E_{corr}) are summarized in Table 1.

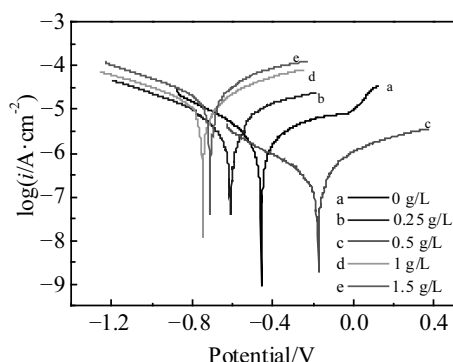

Fig.8 Potentiodynamic polarization curves of Al_2O_3 /cerium oxide composite films acquired from the electrolyte with different concentrations of BTA

Table 1 Corrosion current density (i_{corr}) and corrosion potential (E_{corr}) obtained from potentiodynamic polarization curves in Fig.8

BTA/ $\text{g}\cdot\text{L}^{-1}$	0	0.25	0.5	1.0	1.5
$-E_{\text{corr}}/\text{V}$	0.458	0.610	0.174	0.747	0.713
$i_{\text{corr}}/\mu\text{A}\cdot\text{cm}^{-2}$	1.106	1.454	0.245	10.20	18.62

The test results of the potentiodynamic polarization curves show that under the condition of BTA addition, with the increasing contents of BTA, the resistance corrosion of Al_2O_3 /cerium oxide composite films is first increased and then decreased. The rank of resistance corrosion of composite films from strong to weak is: $0.5 \text{ g/L} > 0.25 \text{ g/L} > 1 \text{ g/L} > 1.5 \text{ g/L}$. The results of the comparison between the solution containing and without BTA can be concluded that adding suitable BTA can effectively enhance the corrosion resistance of Al_2O_3 /cerium oxide composite films. In Table 1, when adding 0.5 g/L BTA into the solution, the corrosion resistance is significantly better than that in the case without BTA. The corrosion current density is reduced by an order of magnitude, and the corrosion potential also has a greater degree of positive shift. While when adding too much BTA, for example 1 g/L or 1.5 g/L , the corrosion current density increases by an order of magnitude, and the corrosion potential shifts negatively. The corrosion resistance of the composite films is even worse than that in the case without adding BTA.

According to the microstructure of the composite films with corrosion resistance, it can be learnt that the adding of appropriate BTA can effectively improve the corrosion resistance of the films. BTA is adsorbed on the surface of the Al_2O_3 porous layer as an aluminum corrosion inhibitor, and it can be complexed with the cerium ions. With the adsorption and complexation, BTA can effectively control the deposition of cerium ions. When BTA is 0.5 g/L , the deposition effect of cerium ions is the best. Also, the surface uniformity and smoothness of the composite films are both enhanced. And

there is no crack, which can decrease the channels for the corrosion ions to invade the matrix. So the corrosion resistance of the composite films is greatly improved. However, when the concentration of BTA is too high ($1.0, 1.5 \text{ g/L}$), the adsorption and complexation of BTA are both too strong, which will seriously impede the deposition of cerium ions, so the cerium conversion coatings can not completely cover the Al_2O_3 film. Part of the Al_2O_3 film is exposed to the air, which provides the accesses for the corrosion ions to etch the substrate. Therefore, the resistance corrosion of composite films at this time is even worse than that in the case without BTA. If the added BTA is too little, the adsorption and complexation are not effective enough to control the deposition of cerium ions. So the microstructure and corrosion resistance of Al_2O_3 /cerium oxide composite films will not get a good improvement, and their properties are quite comparable with those of the films gained from the solution without BTA.

3 Conclusions

1) Adding BTA can effectively improve the surface microstructure of Al_2O_3 /cerium oxide composite films, reduce the surface crack and make the films become more uniform and smoother.

2) The optimal concentration of BTA is 0.5 g/L , and the corrosion current density of Al_2O_3 /cerium oxide composite film is $0.245 \mu\text{A}/\text{cm}^2$, and the corrosion potential is -0.174 V . Compared with no adding of BTA, the corrosion current density decreases by one order of magnitude, and the corrosion potential shifts positively by 0.284 V . At the same time, the corrosion resistance of Al_2O_3 /cerium oxide composite films is effectively enhanced.

References

- Zhang H, Chen Y, Luo A A. *Scripta Materialia*[J], 2014, 86(10): 52
- Sun H, Wang H, Meng F. *Journal of Rare Earths*[J], 2011, 29(10): 991
- Zhao J M, Chen S L, Huo P. *Corrosion Engineering Science and Technology*[J], 2012, 47(3): 203
- Choudhary R K, Mishra P, Kain V et al. *Surface and Coatings Technology*[J], 2015, 283: 135
- Liang T Q, Yang X F, Fan X S et al. *Applied Mechanics and Materials*[J], 2014, 687-691: 4277
- Hu N, Dong X, He X et al. *Corrosion Science*[J], 2015, 97: 17
- Wang S, Peng H, Shao Z et al. *Surface and Coatings Technology*[J], 2016, 286: 155
- Whelan M, Cassidy J, Duffy B. *Surface and Coatings Technology*[J], 2013, 235: 86
- Lee J, Kim Y, Jang H et al. *Surface and Coatings Technology*[J], 2014, 243(4): 34
- Wen Y Q, Meng H M, Shang W et al. *Applied Mechanics and Materials*[J], 2011, 71-78(2): 2361
- Mohammadi I, Afshar A. *Surface and Coatings Technology*[J],

- 2015, 278: 48
- 12 Kiyota S, Valdez B, Stoytcheva M et al. *Journal of Rare Earths*[J], 2011, 29(10): 961
- 13 Nicolo A D, Paussa L, Gobessi A et al. *Surface and Coatings Technology*[J], 2016, 287: 33
- 14 Li Q, Tang Y, Zuo Y. *Materials Chemistry and Physics*[J], 2010, 120(2-3): 676
- 15 Whelan M, Barton K, Cassidy J et al. *Surface and Coatings Technology*[J], 2013, 227: 75
- 16 Zhao D, Wang M, Xu Y et al. *Surface and Coatings Technology*[J], 2014, 238: 15
- 17 Valdez B, Kiyota S, Stoytcheva M et al. *Corrosion Science*[J], 2014, 87: 141

苯骈三氮唑对铝表面 Al_2O_3 /氧化铈复合膜耐蚀性的影响

王桂香, 高 岗, 韩昕辰, 应丽霞, 马福秋

(哈尔滨工程大学, 黑龙江 哈尔滨 150001)

摘 要: 采用阳极氧化法和化学浸渍法相结合的方式在铝表面制备了 Al_2O_3 /铈氧化物复合膜。首先在硫酸溶液中对铝进行阳极氧化, 然后将阳极氧化后的铝在 $\text{Ce}(\text{NO}_3)_3$ 溶液中进行化学转化处理。探究了溶液中苯骈三氮唑 (BTA) 的浓度对所制备的 Al_2O_3 /铈氧化物复合膜抗腐蚀性能的影响。采用 X 射线衍射仪 (XRD)、X 射线光电子能谱 (XPS)、扫描电子显微镜 (SEM)、电化学工作站等技术手段对复合膜的性能进行了表征。测试结果表明, 当 BTA 的加入浓度为 0.5 g/L 时, 铈离子沉积效果最佳, 所制备复合膜表面的平整性和光滑性得到了良好的改善, 此时的复合膜抗腐蚀性能明显提高。

关键词: 铝; 铈转化膜; 苯骈三氮唑; 腐蚀性能

作者简介: 王桂香, 女, 1978 年生, 博士, 副教授, 哈尔滨工程大学, 黑龙江 哈尔滨 150001, E-mail: wgx0357@126.com